U.S. CONSUMER PRODUCT SAFETY COMMISSION



Office of Compliance Requirements¹ for Bunk Beds

16 C.F.R. Part 1213, 1500, and 1513

What is the purpose of the bunk bed rule?

This rule reduces the risk that children may be injured or killed from being trapped between an upper bunk and a wall, in openings below the guardrails, or in openings in the ends of bunk beds.

Where can I find the requirements for bunk beds?

The requirements for adult bunk beds can be found at 16 C.F.R. Part 1213 and the requirements for children's bunk beds can be found at 16 C.F.R. 1513.

What is a bunk bed?

A bunk bed is a bed with the bottom of its mattress foundation more than 30 inches above the floor. The mattress foundation is the base or support on which you place the mattress. The ends of a bunk bed are the upright parts at the head and foot of the bed to which you attach the side rails.

What does the rule require?

Guardrails:

- (1) Bunk beds must have at least two upper bunk guardrails, with at least one rail on each side. Lower bunks with mattress foundations that are 30 inches or less from the floor do not have to have guardrails.
- (2) The guardrail on the side of the bed next to a wall or on the side opposite to a ladder must run continuously from one end of the bed to the other. If the guardrail does not attach to an end of the bed, the gap between the end of the guardrail and the nearest end of the bunk bed cannot be greater than 0.22 inches.
- (3) A guardrail on the side of the bed away from the wall does not have to run continuously from end to end of the bed, BUT the distance between either end of the guardrail and the end of the bed nearest to it cannot be greater than 15 inches.
- (4) Guardrails must be attached to the bunk bed with fasteners that you have to release to take the rails

off OR they must require you to move them in two or more different directions, one after the other, to take them off.

- (5) The tops of the guardrails must be no less than 5 inches above the top of the mattress.
- (6) When you take the mattress off the upper bunk, any space between the bottom of the guardrail and the top of the mattress foundation must not let the wedge block described below pass through freely.

Bunk Bed Ends:

- (1) No opening in either end of the upper bunk that is above the mattress foundation can let the wedge block pass through freely.
- (2) When you use the thickest mattress and mattress foundation recommended by the manufacturer, the top of each end of the upper bunk must be at least 5 inches above the top of the mattress for at least half of the distance between the posts on each side of the end.
- (3) No opening in either end of the lower bunk below the mattress foundation of the upper bunk and above the mattress foundation of the lower bunk can permit the wedge block to pass through freely, UNLESS the opening also allows a rigid 9 inch sphere to pass through it freely.
- (4) Any opening in either end of the lower bunk below the mattress foundation of the upper bunk that is tested with the wedge block must also be tested for the risk of neck entrapment if the opening lets the 9 inch sphere pass through freely.

How do you test a bunk bed for entrapment hazards?

For detailed information on testing bunk beds, see 16 C.F.R. 1213.4 and 1513.4.

With no mattress on the bed, use the wedge block shown in Figure 1 to probe spaces between the guardrail and upper bunk mattress foundation and openings in the upper and lower bunk ends. Place the

¹ The following is a general summary of the requirements for bunk beds and does not replace the requirements published in 16 C.F.R. 1213 and 1513. This summary does not include all of the details included in those requirements. For those details, please refer to the regulation or contact the Office of Compliance.

wedge in the position in which it is most likely to pass through the space or opening, and then use the hook to pull the nose of the wedge into the space or opening. When testing spaces between the guardrail and upper mattress foundation, pull the wedge gradually and sustain a force of 33 foot-pounds for one minute.

If the wedge block passes through any opening in the lower bunk end freely, try to pass a 9-inch diameter rigid sphere through that opening. If the sphere passes through freely, test the opening for neck entrapment.

Repeat these tests with the thickest mattress and mattress foundation recommended by the manufacturer in place

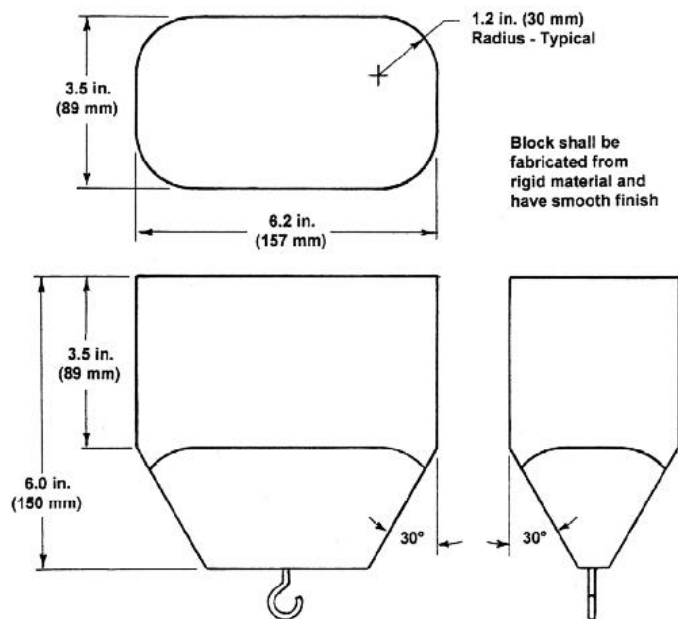

Figure 1 - Wedge Block

How do you test for neck entrapment?

The test for neck entrapment uses a specially designed probe that simulates a child’s head and neck (Figure 2) that is inserted into each opening according to a precise procedure. Because of the detail involved in performing the test, we have not attempted to summarize this procedure. For more detailed information, please refer to 16 C.F.R. 1213.4(c)(3) or 1513.4(c)(3) or contact the Office of Compliance.

Are there labeling requirements for bunk beds?

Yes. Each bunk bed must contain a specific warning label AND a label or marking with the name and address of the manufacturer or importer, model number, and month and year of manufacture. Instructions giving the proper size and thickness of the mattress and containing specific warnings for safe use must also accompany each bunk bed set.

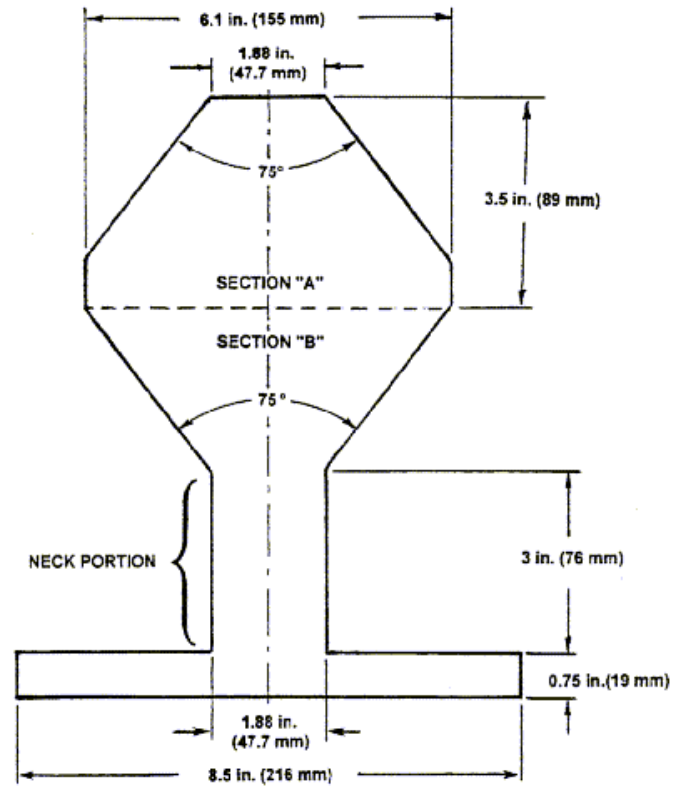

Figure 2 - Test Probe for Neck Entrapment

Are there any other requirements that apply to bunk beds?

Yes. Bunk beds for children may not have sharp points or edges. No bunk bed may be painted with lead-containing paint. (See 16 C.F.R. 1500.48, 16 C.F.R. 1500.49, and 16 C.F.R. Part 1303).

Are there any other standards for bunk beds?

ASTM F 1427-96, a voluntary standard entitled “Standard Consumer Safety Specification for Bunk Beds,” contains other requirements for the design and performance of bunk beds.

Where can I find additional information?

You can obtain the standards from our Web Site at: <http://www.cpsc.gov> or by contacting the Consumer Product Safety Commission, Office of Compliance, Washington, D.C. 20207, telephone: (301) 504-7913, e-mail: sect15@cpsc.gov.

For ASTM F 1427-96, the Standard Consumer Safety Specification for Bunk Beds, contact the American Society for Testing and Materials (ASTM), 100 Barr Harbor Dr., West Conshohocken, PA 19428-2959, telephone: (610)-832-9585, Fax (610)-832-9555, or visit <http://www.astm.org>.