

Wall Street II Pen Kit



149279

Product #: 146595, 146596, 147459, 147460, 148764, 148777, 149244, 149278, 149279, 149573, 149574, 150547, 153121, 834131

12/3/201

From Setup To Sanding:

These are the supplies we suggest you have on hand to complete this pen kit:

- $27/64$ " Pen Maker's Bit
- $3/4$ " x $3/4$ " x $23/8$ " Pen Blank
- Pen Mandrel
- Wall Street II Bushings (146597)
- Thick CA or 5 Minute Epoxy
- Drill or Drill Press
- Sandpaper/MicroMesh
- Barrel Trimmer
- Pen Press
- Eye & Ear Protection
- Dust Mask

Cutting & Drilling Blanks:

Note: Additional length has been added to the overall length of the blank to accommodate for squaring the ends of the blank.

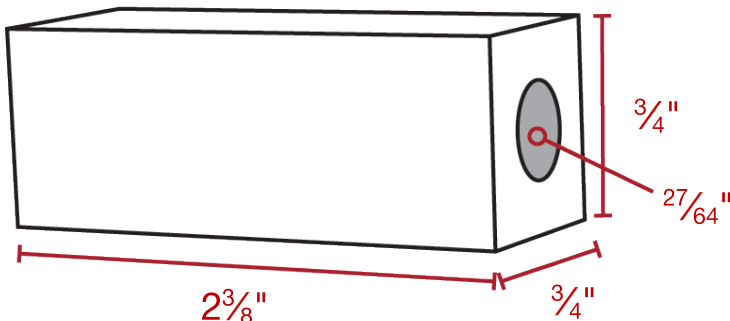
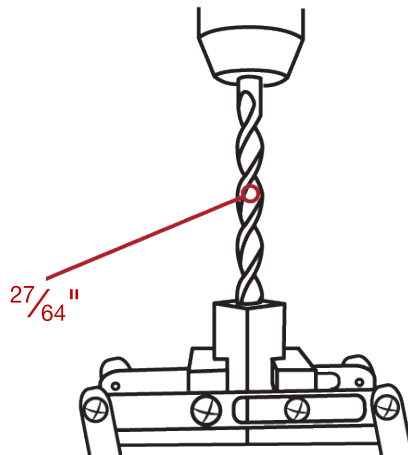

Gluing Blanks to Tubes:

Rough the entire surface of the tube using 180 grit paper. Next, using either a thick CA or 5 Minute Epoxy, apply adhesive to both the tube and the inside of the blank. To secure the brass tube into the inside of the blank make sure to rotate the tube as you insert it into the blank. This will help ensure even coverage of the adhesive and a much more secure bond.

Squaring the Blank to Length:

When squaring the blanks to length ensure to only go to the brass. Removing brass will affect the overall length of the blank which is critical to the proper operation of the pen.

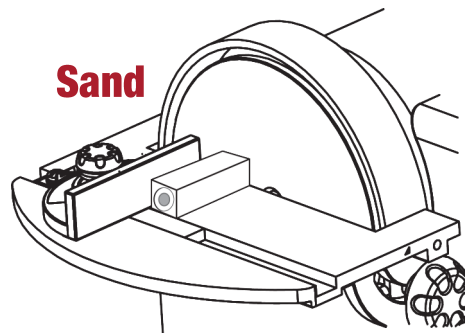

Mandrel Preparation:

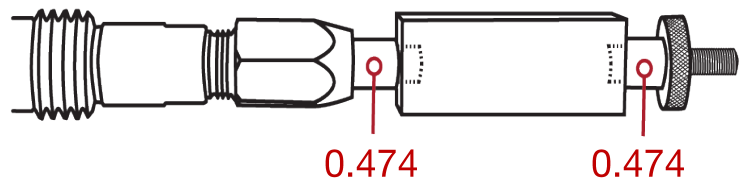

Turning & Finishing the Blanks:

Turn the blank to your desired profile leaving the blank slightly proud of the bushings. With the lathe spinning, begin sanding with 120 grit paper progressing through the finer grits finishing at 320 grit. Once finished with sanding apply a finish of your choice.

Wall Street II Pen Kit

Product #: 146595, 146596, 147459, 147460,
148764, 148777, 149244, 149278, 149279,
149573, 149574, 150547, 153121, 834131

12/3/201

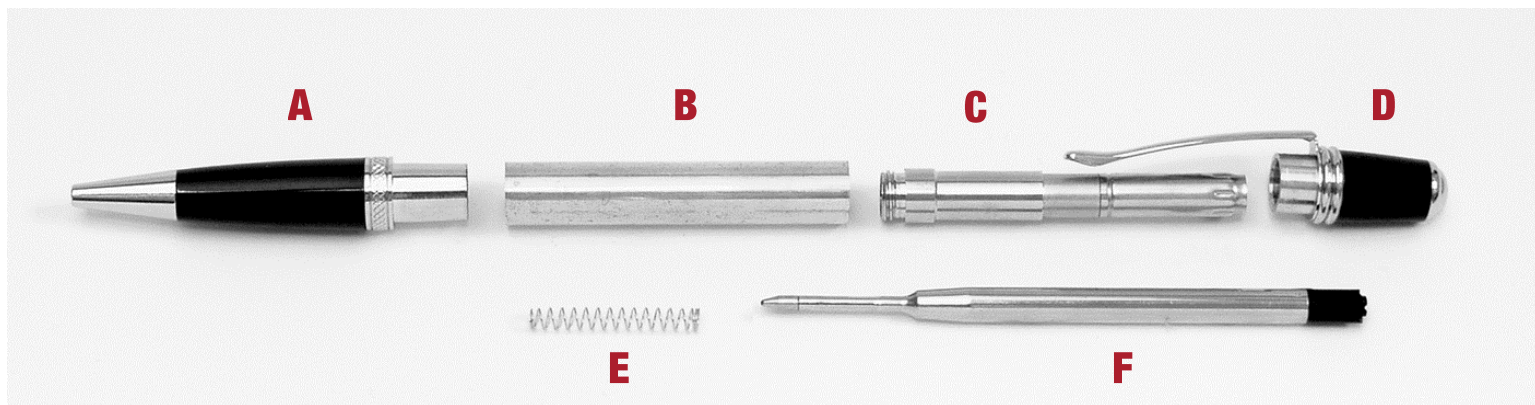

Assembly:

- Slide Spring (E) onto the end of the Ink Refill (F) and insert the spring end into the Nib Assembly (A).
- Slide the Twist Mechanism (C) threaded end first over the Ink Refill (F), and screw the Twist Mechanism (C) into the Nib Assembly (A).
- Press the Cap/Pocket Clip Assembly (D) into one end of the turned blank/tube (B) to form the pen body.
- Slide the open end of the pen body over the Twist Mechanism (C) and onto the shoulder of the Nib Assembly (A) until it seats against the center ring.

To advance the ink refill turn the body clockwise, to retract the ink refill turn the body counter clockwise.